



Best™ Integrated Brachytherapy Solutions



Best™ HDR Remote Afterloader

BestMick Applicator



BestMick 10/15/20/25 Cartridges

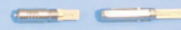

Best™ Kobold Tandem & Ring Applicator

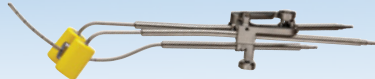

Best™ Kobold Fletcher Tandem & Ovoid Applicator



Best™ Kobold Henschke Tandem & Ovoid Applicator



Best™ Compact Sonalis™ Ultrasound Imaging System



Best™ Treatment Planning System



Best™ Stepper/Stabilizer

Best™ Esophageal Brachytherapy Applicator

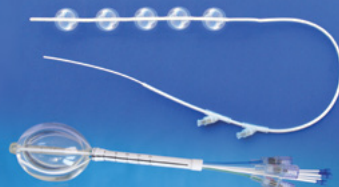

Best™ Breast Double-Balloon Brachytherapy Applicator

Best™ Flexi Needles

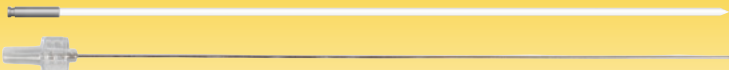

15G Flexi Needle



16G Flexi Needle



17G Flexi Needle



15G Flexi Needle with SS Sleeve (Click Fit)



Flexi Needle with Female Hub

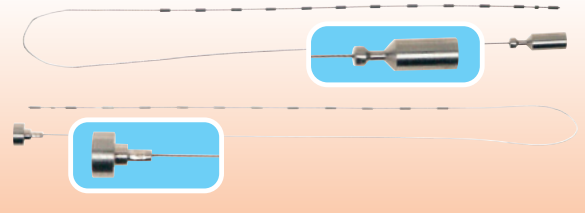

Best™ X-ray Marker Cables

Best™ vascular



Vascular Brachytherapy for In-stent Restenosis

VBT Designed for the Cath Lab



- Convenient & Minimal Dosimetry Calculations
- Portable & Reusable
- Compatible with 6F Guide & 7F Guide-Extending Catheters
- Short Treatment Time



Available in 30 mm, 40 mm & 60 mm Source Train Lengths



Which of the following companies is still the most reliable and trusted source of Iodine-125 and Palladium-103 seeds for prostate brachytherapy?

Best Medical International

- ~~Coloplast~~
- ~~Cytogen~~
- ~~DraxImage~~
- ~~Imagyn Medical~~
- ~~Implant Sciences~~
- ~~International Isotope~~
- ~~Isotope Products Laboratory~~
- ~~Mallinckrodt~~
- ~~Med-Tec~~
- ~~Mentor~~
- ~~Mills Pharmaceutical~~
- ~~NASI~~
- ~~Oncura~~
- ~~PSA~~
- ~~Source Tech~~
- ~~Syncor~~
- ~~UroCor~~
- ~~UroMed~~



Best™ Iodine-125 Seed

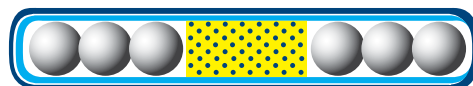

Best™ Palladium-103 Seed

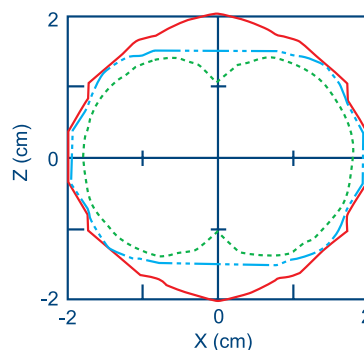
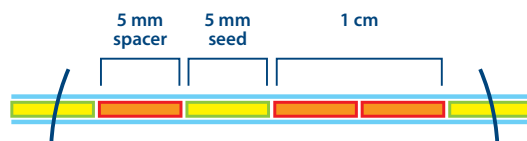

Experimentally Measured Isodose Curves of 20 cGy/h from I-125 Seeds, Best™ Model 2300 Series (solid red line), Model 6702 (broken blue line) and Model 6711 (dotted green line).

— Ravinder Nath and Anthony Melillo
Medical Physics, 20(5), 1480 (1993)

Only Best Medical International!

- ✓ From 0.05 mCi to 10 mCi per I-125 seed and 0.5 mCi to 3 mCi per P-103 seed, orders are custom manufactured and prepared in Springfield, Virginia USA
- ✓ Best visualization in ultrasound, fluoro, X-ray, CT and MRI, facilitating real-time dosimetry
- ✓ Assistance setting up new programs (licensing, procurement of equipment, proctoring, reimbursement consulting, patient education and marketing)

We ship your custom order within **24 hours** Sterile & Non-Sterile

Why Medical Physicists, Radiation Oncologists and Urologists Prefer Best™

Go for the Best™ for your patients!

You don't go to a shoe store and cut your feet to fit the shoe they have in stock ... then why compromise when it comes to improving the clinical outcome for your patients?

"A unique aspect of the Best™ seed is its 5 mm length. Best also provides 5 mm laser-cut spacers, which do not have flared edges. With the Best® seed/spacer combination, we can be more confident of accurate seed placement." ¹

Best™ Fiducial Markers

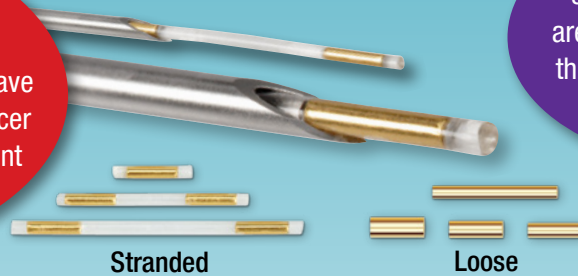

"The source strengths of Best™ seeds are uniformly distributed and the values always fall within the $\pm 3\%$ criterion." ³

"Best™ Model 2301 seeds are of superior design as they show up more distinctly in transverse ultrasound and fluoroscopic images." ³

"Best™ Model 2301 characteristic x-rays have no significant effect on the photon spectrum and the source emits an essentially pure I-125 decay scheme spectrum." ^{2†}

Best™ Localization Needles with I-125 Seeds



"Best™ Model 2301 is the most isotropic of all the I-125 sources currently available. The source is a double encapsulated source." ²

Best™ Palladium-103 Seed



Best™ Iodine-125 Seed



"Delivery of the specific Sk for any given date, delivered on the date requested prior to the procedure. Extremely high level of flexibility, e.g. seed date changes, activity changes, etc. Prompt, courteous customer service, and low price." ⁴

¹ Communication from J. Limmer, UW Cancer Center Wausau Hospital, Wausau, Wisconsin – Dated December 14, 2000. ² B.H. Heintz, R.E. Wallace & J.M. Hevezi, Med. Phys. 28(4) 671-682 (2001). ³ Communication from Khai Lai, Kreitton Oncology Services Shoreline, Washington – Dated March 8, 2001. ⁴ Jeff Limmer, Medical Physicist.



Best Medical is the **only** company that makes custom seeds and strands to your exact specifications—any source, any configuration, any time!



Best™ Brachytherapy Needles

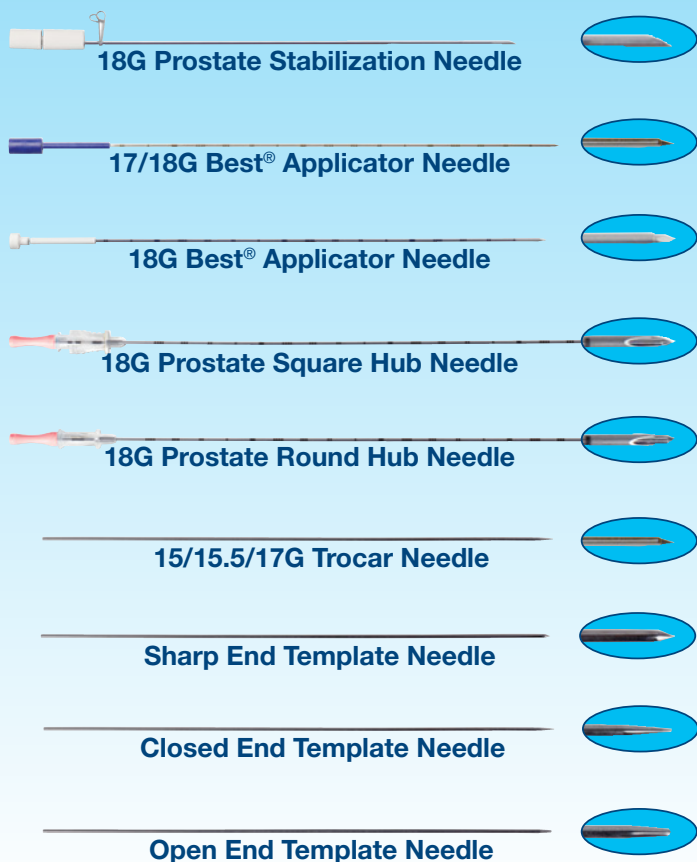

These HDR Needles are used with the templates, which improve the homogeneity of radiation. Needles of different lengths, closed end or open end, with or without collar, with or without funnel, are available.

Implant Needles are made of Stainless Steel and are hollow with different types of bevel at one end. Various lengths in different gauges are available, though the most commonly used needle is the 18G. Custom diameters and lengths are available upon request.

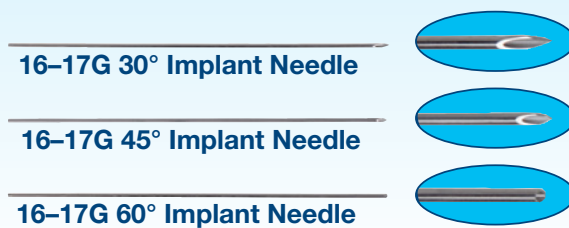

Best™ Brachytherapy Kit



5 Friction Cuffs



5 Half Moon Buttons*



5 Red Caps

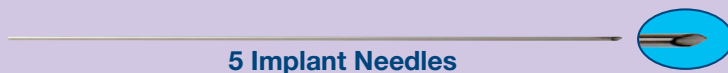

5 Implant Needles

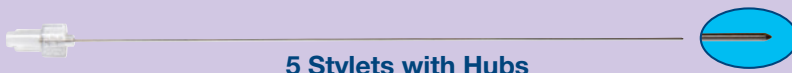

5 Stylets with Hubs

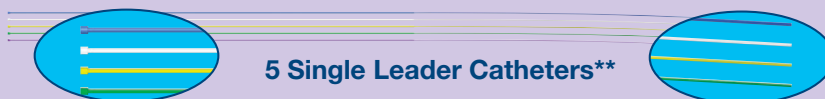

5 Single Leader Catheters**

* Half Moon Buttons are available in either radiopaque (pictured above) or clear nylon.

**Catheter tubes are available in purple, green, yellow, clear or blue with either radiopaque or clear nylon buttons.

Best™ Prostate, Rectal, GYN and Stepper/Stabilizer Templates



Best Medical offers a wide variety of disposable templates for HDR and LDR applications. Specify hole size when ordering (15, 16 or 17 gauge). These products should be carefully inspected by your staff prior to clinical use and should be used by authorized personnel only.

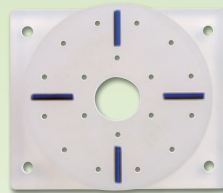

LDR Prostate Template (Disposable)

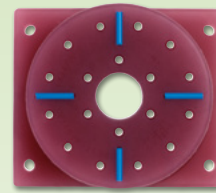

HDR Prostate Template (Disposable)

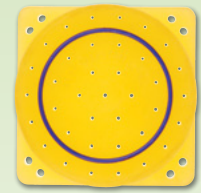

Rectal Template (Disposable)

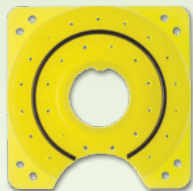

Modified Rectal Template (Disposable)

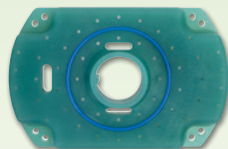

GYN Template (Disposable)

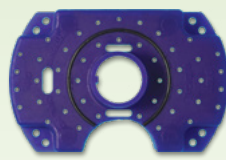

Modified GYN Template (Disposable)

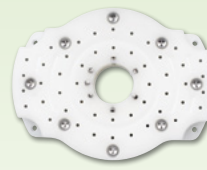

GYN Template (Reusable)

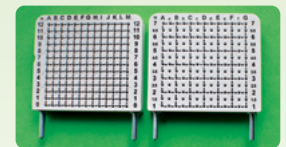

Grid Template for B-K type Stepper/Stabilizer* (Disposable)

Best™ Syed Multi-Channel Vaginal Applicator

This novel HDR applicator consists of a disposable central insert and an outer sleeve along with a positioning collar. **Source channels travel fully to the distal end, curving around to give more dose to the apex area, allowing for optimum dose delivery.**

Additionally, the outer sleeve provides a 5 mm wall, to reduce dose to the vaginal mucosa, with a 2 mm wall at the distal end of the applicator to allow for greater dose delivery. The applicator is 18 cm in length with diameters ranging from 2.0 cm to 3.5 cm.**

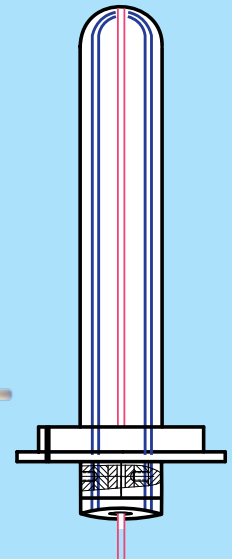
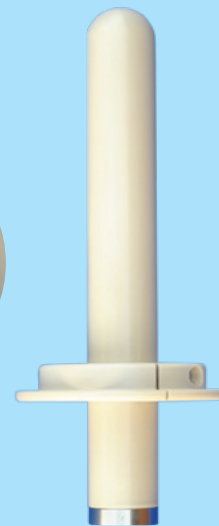

Huestis Fixed Lasers—Red or Green Diode



Huestis CVO-2000 Warming Oven for Thermoplastics



mobileMOSFET Wireless Dosimetry System



Portable Dosimetry System

*BMI provides grid templates for all makes and models of steppers/stabilizers. **All dimensions are approximate.

Best™ Theratronics

A TEAMBEST GLOBAL COMPANY



Best™ GammaBeam™ 300-100 CM, 100-80 CM Equinox™ Teletherapy System with Avanza 6D Patient Positioning Table

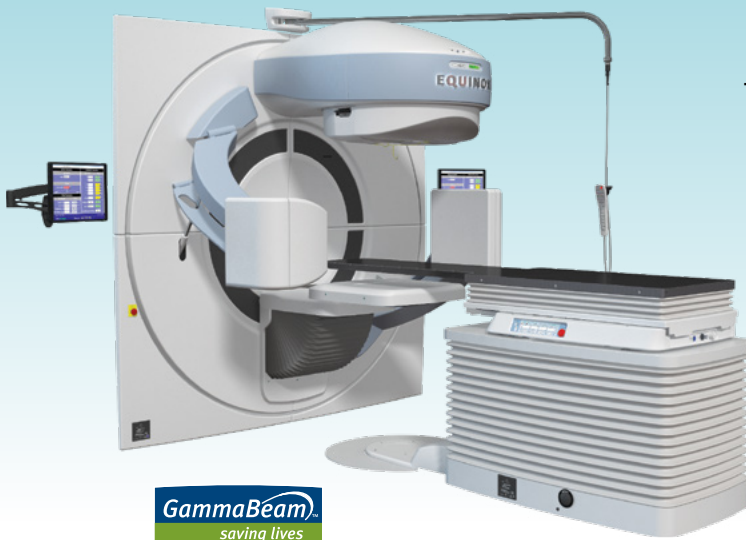

NEW! Multi-Leaf Collimator (built in or external)
for 80 and 100 cm SAD units—IMRT, IGRT,
SRS, SBRT and Tomotherapy capable w/ActiveRx

UPGRADE Kit

for all old Theratron
units, 80 or 100 cm
including IMRT
capabilities w/built
in or external MLC



UPGRADE includes:

- Removing all old controls, electronics and installing a new control system and covers
- Replacing the old collimator system with the new Equinox collimator
- Replacing the old treatment table with the new Avanza™ Table
- Retaining the head rotation capability is optional

UPGRADE features:

- Calculated Arc Speed
- Graphical Control System
- Asymmetric Jaws
- R&V System Ready
- Service Log Files
- On-Board Verification
- Motorized Wedge
- Collision Detection

*Certain products shown are not available for sale currently.

Best Theratronics Ltd. 413 March Road, Ottawa, Ontario K2K 0E4 Canada

tel: 613 591 2100 866 792 8598 www.theratronics.com www.teambest.com

Best™ *medical international*

A TEAMBEST GLOBAL COMPANY



What do all these companies have in common?

They got their start in the 1970's

Apple Inc. • Atari, Inc.
Best Medical International
Ben & Jerry's • Chili's
Charles Schwab Corp.
Days Inn • FEDEX
Foot Locker • Freddie Mac
Home Depot • Microsoft
NPR • Starbucks
Warner Media • UnitedHealth

HUESTISMEDICAL
making it affordable™

Best™ Universal Chair/Table Model UCT-1000



Useful for:

GYN, Prostate, and other Brachytherapy (HDR/LDR) procedures in Urology and General Practice

- Electronic
 - Variable Height Control
 - Variable Back Support
 - Variable Foot Support
 - Horizontal Tilt 12 Degrees Head or Foot
- 4-Function Hand-Held Pendant (Control)
- Removable Stainless Steel IV Pole
- Removable Foot Rest

Huestis Medical • 68 Buttonwood Street • Bristol, Rhode Island 02809-0718 USA
tel: 401 253 5500 800 972 9222 www.huestismedical.com

AccuBoost[®] DIGITAL

PARTIAL BREAST BRACHYTHERAPY SOLUTION

AccuBoost[®] Digital—A digital mammography-guided Non-Invasive Breast Brachytherapy (NIBB) equipment solution. This complete, turn-key solution provides all the components needed for this advanced treatment, bundled together in a streamlined offering.



HUESTIS MEDICAL
A TEAMBEST GLOBAL COMPANY

68 Buttonwood St., Bristol, RI 02809

1-800-972-9222

www.accuboot.com • www.huestis.com • www.teambest.com

Best[™] nomos[®] Compact Sonalis[®] Ultrasound System

The Best[™] Sonalis[®] Ultrasound Imaging System provides superior visualization of HDR, LDR, RF or Cryosurgical procedures. Our patented SimulView[™] Technology provides simultaneous “live” views of the prostate in both planes, thereby increasing treatment accuracy and precision.

Additional Features

- Capable of supporting over 20 different probe configurations, this system can be used in almost every discipline
- 21.5" touch screen technology
- Superior HD image resolution for improved procedure accuracy, speed and physician confidence level
- Patented probe design
- Sagittal array provides for 140 mm length of view encompassing the bladder, prostate and perineal tissue
- Advanced modular software design provides for future upgrade path
- Convertible to desktop or portable without losing any functionality
- Dual battery backup built-in to protect from power loss







**Certain products shown are not available for sale currently.*



Sonalis[®] Transducers

We offer probes for the most common types of procedures and imaging, all with the enhanced image quality and high resolution that you would expect from the **BEST** name in ultrasounds!

- 8L2A Linear Array 
- 12L5A Linear Array 
- 14L3 Linear Array 
- 15LW4 Linear Array 
- 15LA Linear Array 
- 15L4A Linear Array 
- 16L5 Linear Array 
- 8V3 Phased Array 
- 4V2A Phased Array 
- 5C2A Curved Array 
- 9MC3 Curved Array 
- 8EC4A Endocavity 
- XY-BI-Plane Phased Array 
- 10EC4A Endocavity 
- 10BP4 Bi-Plane 
- 8BP4 Bi-Plane 
- 8TE3 Trans-esophageal 
- Pedoff 
- 16HL7 High Frequency Linear Array 

Best Nomos • One Best Drive • Pittsburgh, PA 15202 USA

tel: 412 312 6700 or 800 70 NOMOS • fax 412 312 6701 • www.nomos.com