

Welcome to Our World

TEAMBEST GLOBAL®



www.teambest.com

- **Arplay Medical** www.arplay.com
- **Best ABT** www.bestabt.com
- **Best Automation & Robotics** www.teambestautomation.com
- **Best Cyclotron Systems, Inc.** www.bestcyclotron.com
- **Best Dosimetry Services** www.bestdosimetry.com
- **Best Medical Canada** www.bestmedical.ca or www.mosfet.ca
- **Best Medical International** www.bestmedical.com
- **Best NOMOS** www.nomos.com
- **Best Particle Therapy** www.bestproton.com
- **Best Theratronics** www.theratronics.com
- **Best Vascular (Novoste)** www.bestvascular.com or www.novoste.com
- **CNMC Company** www.cnmcco.com
- **Huestis Medical** www.huestis.com

**Ready to serve globally
for all your needs**



TeamBest Offers Best™ Total Solutions™ to Customers



Best Medical International, Inc. (BMI) was founded by Krishnan Suthanthiran in 1977 in Springfield, Virginia, USA and has expanded since that time to become a global business serving customers worldwide. Best's family of companies, collectively known as **TeamBest**, is a vertically integrated enterprise that has developed a reputation for being the best and most experienced in the field of radiation therapy products, technologies and instruments. TeamBest's goal is to reduce healthcare costs by controlling the supply chain and manufacturing costs, as well as deliver unmatched customer service. TeamBest provides Total Solutions™ for all radiation therapy/diagnostic product and instrument needs.

One World • One Source • The Best!

Best Medical International

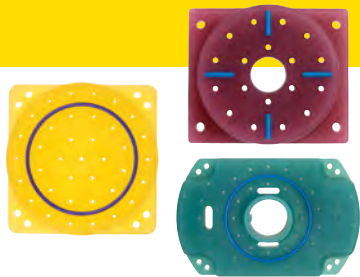

Best™ Templates



Best™ Iodine-125 Seed



Best™ Palladium-103 Seed



Best™ Flexi
Needles

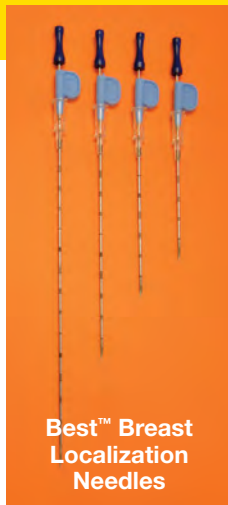

Best™ Breast
Localization
Needles

BMI has been supplying quality radiation therapy products to the brachytherapy community at affordable prices since 1977. BMI manufactures Best™ Iodine-125 and Best™ Palladium-103 seeds in nylon ribbons, Low Dose Rate/High Dose Rate brachytherapy accessories (catheters, needles, applicators, templates, etc.), Fiducial Markers in loose and stranded configurations, the Best Brachytherapy Kit, Breast Localization Needles, Double-Balloon Breast Brachytherapy Applicators, Cobalt-57 Nuclear Medicine Sources, and several other customized products. Seeds are available to suit customer choices, either loose or loaded in cartridges, needles or strands, sterile or nonsterile.

(continued on next page)



Orders shipped within
24 hours/7 days a week,
anywhere in the world!

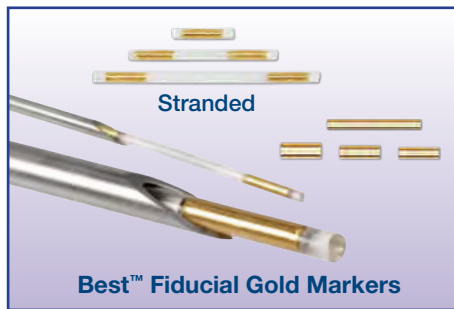

Best™ Fiducial Gold Markers



Best™ Brachytherapy Kit

Best Medical International • 7643 Fullerton Road • Springfield, VA 22153 USA
tel 703 451 2378 800 336 4970 www.teambest.com

AFRICA | ASIA | EUROPE | LATIN AMERICA | MIDDLE EAST | NORTH AMERICA

Best Medical International (continued from previous page)

Our Brachytherapy products are manufactured with pride in the USA—
providing everything you need from One World • One Source • The Best!

- Ultrasound Imaging Systems
- HDR Remote Afterloaders/Accessories
- LDR/HDR Templates
- Treatment Planning Systems
- Stepper/Stabilizers and more!



Best™ Stepper/Stabilizer



**Best™ HDR
Remote Afterloader**



**Best™ Universal
Chair/Table**



**Best™ Compact
Ultrasound Imaging
System**

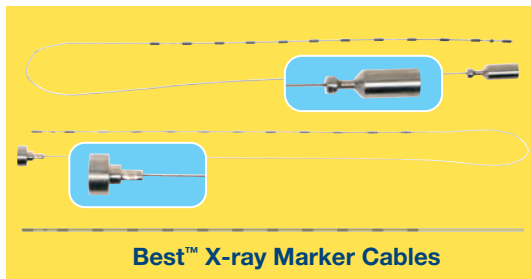

Best™ X-ray Marker Cables

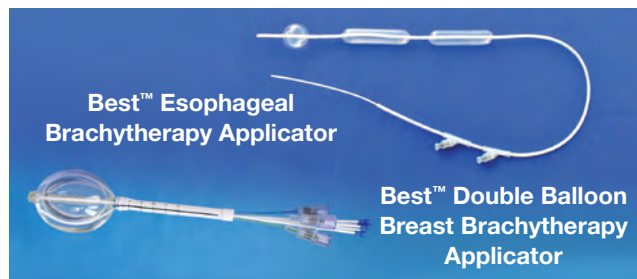

**Best™ Esophageal
Brachytherapy Applicator**

**Best™ Double Balloon
Breast Brachytherapy
Applicator**



Best Medical International • 7643 Fullerton Road • Springfield, VA 22153 USA
tel 703 451 2378 800 336 4970 www.teambest.com

AFRICA | ASIA | EUROPE | LATIN AMERICA | MIDDLE EAST | NORTH AMERICA

Arplay Medical



**Alloy dispenser
and cerrobend**



Mold room

Arplay Medical manufactures and supplies a variety of items needed for mold rooms including customized furniture, alloy dispensers, cooling plates, styrofoam cutters, and fumes extraction and filtration systems. Apart from this, Arplay also offers warming ovens for thermoplastic masks, total body irradiation tables and radioprotection equipment such as leaded screens and emergency containers for brachytherapy. Additionally, Arplay distributes other Teambest products in Europe, Africa, the Middle East, and as far away as the South Pacific.

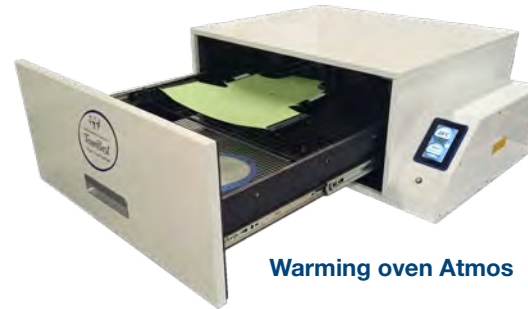

Warming oven Atmos



**Brachytherapy emergency
container**

Arplay Medical • 1 route de Cîteaux • 21110 Izeure, France
tel +33 (0) 3 80 29 74 01 www.arplay.com www.teambest.com

AFRICA | ASIA | EUROPE | LATIN AMERICA | MIDDLE EAST | NORTH AMERICA

Best ABT, Inc

Best ABT, a division of TeamBest Global, is a medical imaging company located in Louisville, TN. ABT manufactures medical biomarker generators intended to facilitate the global expansion of positron emission tomography imaging. The company's based generators include a self-shielded mini-cyclotron for producing the positron-emitting F-18 isotope and a microchemistry system for labeling specific molecules with the positron-emitting isotopes, enabling pharmaceutical companies to produce unit doses of molecular imaging drugs for positron emission tomography (PET) at the point of use.



Best™ BG-95 and B-11



Best ABT, Inc. • 3024 Topside Business Park Drive • Louisville, Tennessee USA
tel 865 982 0098 www.bestabt.com www.teambest.com

AFRICA | ASIA | EUROPE | LATIN AMERICA | MIDDLE EAST | NORTH AMERICA

Best Automation & Robotics

Best Automation & Robotics provides our customers with cost effective automation solutions for a variety of applications. Best Automation & Robotics has extensive experience integrating all types of automation to provide turnkey solutions that will automate your process from raw material through product shipment. We can provide robotic work cells using all the major robot manufactures as well as providing custom robotics for unique applications.



Half (180 Degree) Gantry

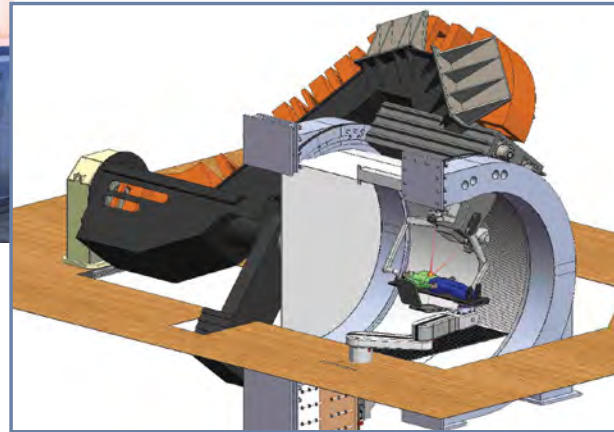

Best Automation & Robotics • 1354 Clifford Avenue • Loves Park, Illinois 61111 USA
tel 877 700 BEST www.teambestautomation.com www.teambest.com

AFRICA | ASIA | EUROPE | LATIN AMERICA | MIDDLE EAST | NORTH AMERICA

Best Cyclotrons Systems

In June 2009, Best Cyclotrons Systems (BCS), together with Best Theratronics Ltd. (BTL), announced their plans for the manufacture of a range of variable-energy cyclotrons from 6 to 70 MeV—models B15P, B25P, B35P, B70P and BG-95—in Ottawa, Ontario. These cyclotrons are developed for use in research, diagnosis and treatment applications at universities and hospitals around the world. BTL and BCS are the only companies in North America producing these cyclotrons and are able to customize them for users based on their needs.

Cyclotrons use a combination of magnetic and radio frequency electric fields to accelerate ions to velocities high enough to create radioisotopes. BTL has a cost-effective, modern technology to manufacture a range of cyclotrons. BCS's innovative plans include the ability to generate new research and clinical radiocompounds, as alternatives to Technetium-99m supply, making them readily available for medical diagnosis and treatment.

BCS and BTL are collaborating with National Laboratories in Europe and the USA to enhance the capabilities of all the cyclotrons. These cyclotrons have external ion sources, allowing for high current cyclotron designs. The system features enable customers to significantly reduce costs for acquisition, maintenance, and operation.



Best™ B35adp Alpha/Deuteron/Proton Cyclotron for medical radioisotope production and other applications

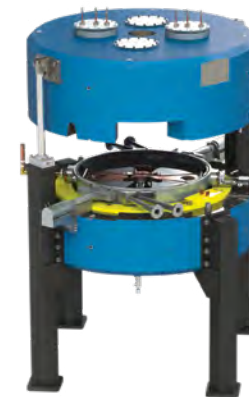

Best™ 6-15 MeV Cyclotron



Installation of Best™ 70 MeV Cyclotron at INFN, Legnaro, Italy.

Best Cyclotron Systems • 8765 Ash Street, Unit 7 • Vancouver, BC V6P 6T3 Canada
tel 604 681 3327 866 909 4647 www.bestcyclotron.com www.teambest.com

AFRICA | ASIA | EUROPE | LATIN AMERICA | MIDDLE EAST | NORTH AMERICA



Best Dosimetry Services



Whole Body Dosimeters

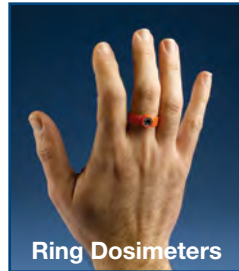

Ring Dosimeters



Best Dosimetry Services (BDS), provides personnel dosimetry services. The service supplies well-established radiation dosimetry badges that utilize the most advanced thermoluminescent dosimetry (TLD) technology available, the high-sensitivity LiF: Mg, Cu, P material.

The dosimeters are nearly tissue-equivalent, exhibit negligible fading, and can detect radiation doses as low as 1 mrem. The service provides radiation monitors for both whole-body and extremity monitoring of radiation dose. BDS is customer oriented, providing a real person to connect with on the phone, and assures fast turnaround of dose results.

Additional radiation safety products and services include: electronic dosimeters, survey meters, instrument calibration and repair.

Best Dosimetry Services • 865 Easthagan Drive • Nashville, Tennessee 37217 USA
tel 615 391 3076 866 492 8058 www.bestdosimetry.com www.teambest.com

AFRICA | ASIA | EUROPE | LATIN AMERICA | MIDDLE EAST | NORTH AMERICA

Best Medical Canada

Best Medical Canada (BMC) is a globally acclaimed leader in the development and manufacture of radiation detection and measurement devices. The company was incorporated in 1984 and since then has worked almost exclusively in radiation detection technologies. The goal of BMC is to offer unparalleled quality products and services to its customers around the world. Its mobileMOSFET Wireless Dose Verification System provides accurate, real-time patient dosimetry information during radiation therapy or diagnostic imaging. BMC's MOSFET dosimeter is the smallest in the world, at 1-millimeter square, and can be used in the most sensitive medical applications. Its products are reliable and safe, providing innovative solutions to radiation measurement problems. BMC supplies Canada with all of the products offered by TeamBest including a complete line of patient positioning products.



Portable
Dosimeter
System



mobileMOSFET
Wireless System



Best Medical Canada • 413 March Road • Ottawa, Ontario K2K 0E4 Canada

tel 613 591 2100 877 668 6636 www.bestmedicalcanada.com www.mosfet.ca

AFRICA | ASIA | EUROPE | LATIN AMERICA | MIDDLE EAST | NORTH AMERICA

Best NOMOS

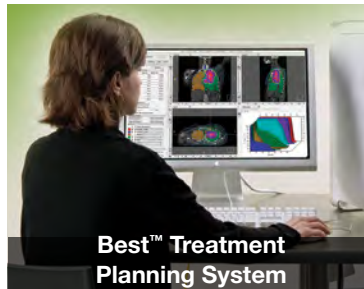

Best NOMOS provides the Best™ Total Solutions™ for prostate cancer diagnosis and treatment. Its Best™ Sonalis® features breakthrough SimulView™ ultrasound technology, with simultaneous imaging of transverse and sagittal planes. Its BATCAM ultrasound-based image-guided radiation therapy units are the proven method for prostate localization during multifractional IGRT treatment.

CORVUS® is an inverse treatment planning system that optimizes a delivery plan of thousands of pencil beams of radiation to meet prescription dose goals and constraints. The only system with Active Rx™, CORVUS provides the ability to “draw” isodose lines, interactively “push” dose and “click and drag” to adjust dose planning volumes to improve the plan with immediate, graphical feedback. It also enhances productivity by eliminating the iterative trial and error process of generating the perfect treatment plan.

(continued on next page)

Best NOMOS • One Best Drive • Pittsburgh, PA 15202 USA
tel 412 312 6700 800 70 NOMOS www.nomos.com www.teambest.com

AFRICA | ASIA | EUROPE | LATIN AMERICA | MIDDLE EAST | NORTH AMERICA

Best NOMOS (continued from previous page)

NomosSTAT™ serial tomotherapy technology delivers pencil beams from a continuous 340-degree arc around the patient, creating a highly conformal dose distribution. Treatments delivered with NomosSTAT provide better critical structure avoidance than other IMRT techniques without compromising dose to the target. These capabilities can be added to any linear accelerator while maintaining the ability to deliver conventional treatments.

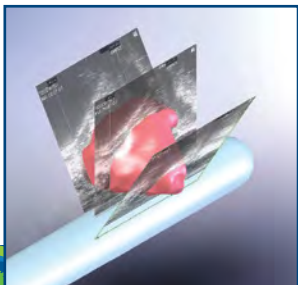

Best™ Ultrasound Imaging System

We offer probes for the most common types of procedures and imaging—all with the enhanced image quality and high resolution that you would expect from the **BEST** name in ultrasounds!



Best Particle Therapy

Best Radiation Therapy/Diagnostic Center

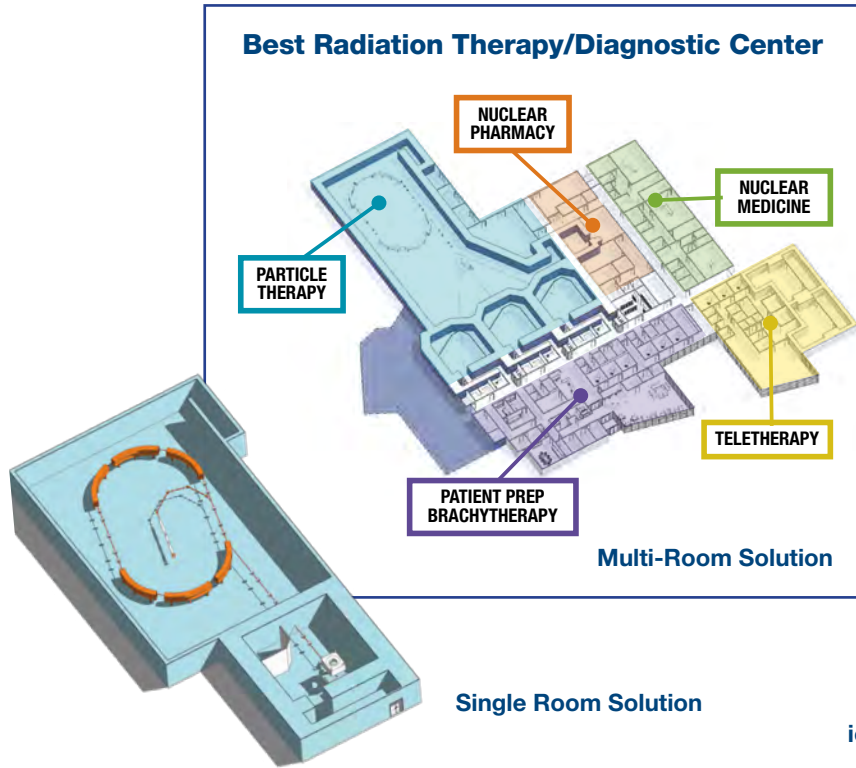

Best Particle Therapy focuses on the development of particle based therapy systems. A Collaborative Research and Development Agreement has been established with the US Department of Energy's Brookhaven National Laboratory (BNL). Under this agreement, BPT/BNL are jointly developing a rapid cycling proton/carbon synchrotron that enables ultimate treatment flexibility. These synchrotrons can be operated at variable energies from Proton to Carbon, in Single or Multi-Room configurations, with or without gantry. The ion Rapid Cycling Medical Synchrotron (iRCMS) program draws on the particle acceleration expertise of Brookhaven Lab researchers and the medical equipment experience of TeamBest companies to advance cancer therapy, in particular through the evolving use of carbon ion and proton beams.



ion Rapid Cycling Medical Synchrotron (iRCMS) Racetrack

Best Particle Therapy • 8765 Ash Street, Unit 7 • Vancouver, BC V6P 6T3 Canada
tel 604 681 3327 866 909 4647 www.bestproton.com www.teambest.com

AFRICA | ASIA | EUROPE | LATIN AMERICA | MIDDLE EAST | NORTH AMERICA

Best Theratronics

What is the most trusted and dependable teletherapy system in the world? Best™ Gamma Teletherapy™— It's a game changer. Best™ Gamma Teletherapy™ systems (Theratrons) have provided low-cost, dependable service worldwide for more than 50 years. Its systems have significantly lower operating costs than linear accelerators (linacs). Millions of cancer patients around the world have received and continue to receive treatment on Theratrons, which can now be equipped with Multi-Leaf Collimators for IMRT and 3D CRT capabilities. The MLC connects modern treatment methods in radiotherapy with high cost-efficiency and maximum reliability for all environments.



Multi-Leaf Collimator



Best™ GammaBeam™ 300-100 CM Equinox Teletherapy System



Best Theratronics • 413 March Road • Ottawa, Ontario K2K 0E4 Canada
tel 343 804 0151 866 792 8598 www.theratronics.com www.teambest.com

AFRICA | ASIA | EUROPE | LATIN AMERICA | MIDDLE EAST | NORTH AMERICA

Best Theratronics

In addition, Best Theratronics is the market leader in blood irradiators, with both gamma and X-ray technology, offering the Gammacell 1000 Elite/3000 Elan and the Raycell Mk2 X-ray irradiator. Depending on the product selected, the required 25 Gy central dose can be delivered in approximately 2–7 minutes. Barcode reading capabilities allow users to track the relevant data associated with each irradiation cycle, including unit number, product code, and blood type.

Best Theratronics also provides research and tissue irradiators for a wide range of clinical and research applications. New to Best Theratronics is the GammaBeam 500 Total Body Irradiator, the first teletherapy unit of its kind designed to produce a large fixed rectangular radiation field at an extended source-to-skin distance in order to deliver total body irradiation.



**Gammacell® 1000 Elite/3000 Elan
Blood & Research Irradiator**



**GammaBeam® 500
Total Body Irradiator**



Raycell® Mk2 X-ray Blood Irradiator



**Raycell® Mk1
X-ray Blood
Irradiator**

Best Theratronics • 413 March Road • Ottawa, Ontario K2K 0E4 Canada
tel 613 591 2100 866 792 8598 www.theratronics.com www.teambest.com

AFRICA | ASIA | EUROPE | LATIN AMERICA | MIDDLE EAST | NORTH AMERICA

Best Vascular/Novoste

In the mid 1990's Best Medical International provided radioactive sources for pivotal research including human studies into restenosis, or re-clogging, in coronary and peripheral vessels. The successful studies resulted in a new modality known as intravascular brachytherapy, or IVBT. The device was CE marked for sale outside the USA in 1999, and approved by the US Food and Drug Administration in November 2000, for treatment of coronary artery in-stent restenosis in failed bare metal stents.

Since then, the procedure and Best's IVBT products have been marketed globally. The Novoste™ Beta-Cath™ System is available through Best Vascular located in Norcross, Georgia, USA, near Atlanta. Best Vascular continues the legacy of intravascular radiation therapy that began with sources from Best Medical International over a decade ago. The positive safety profile of IVBT continues to provide an attractive adjunct therapy to PCI for treating in-stent restenosis. The Novoste Beta-Cath 3.5F System, offered exclusively by Best Vascular, remains an unrivaled system, helping skilled interventionalists to preserve vascular patency in today's challenging in-stent restenosis patient population.

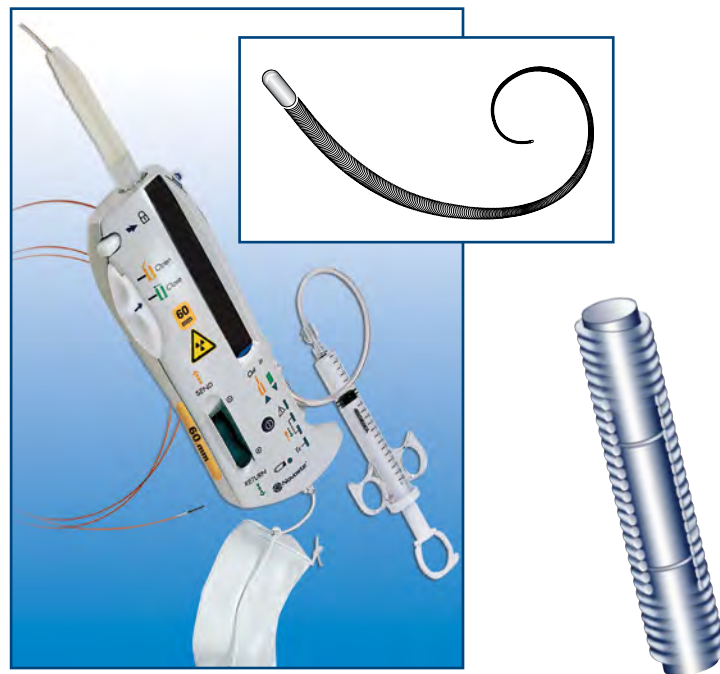

Novoste Beta-Cath 3.5F System

Best Vascular • 4350 International Boulevard, Suite A • Norcross, GA 30093 USA
tel 770 717 0904 800 668 6783 www.bestvascular.com www.teambest.com

AFRICA | ASIA | EUROPE | LATIN AMERICA | MIDDLE EAST | NORTH AMERICA



CNMC Company



Extension Cables



Electrometers

Best™ Total Solutions™ provide for all your physics instrumentation and radiotherapy product needs—quality assurance instruments and products, calibration and repair services for all makes and models. CNMC Company has supplied medical physicists with quality products for radiation dosimetry and quality assurance for more than 30 years. Its well-established relationships with multiple vendors enable it to supply all needed products, including hard-to-find items. CNMC can also repair broken instruments, saving the customer many thousands of dollars, and can often provide a loaner.

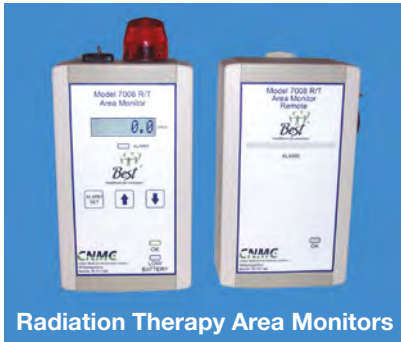

Radiation Therapy Area Monitors



Isocentric Beam Checker

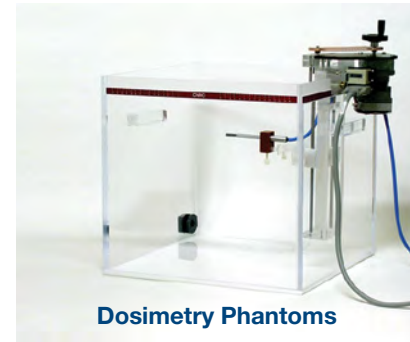

Dosimetry Phantoms

CNMC Company • 865 Easthagan Drive • Nashville, Tennessee 37217 USA
tel 615 391 3076 800 635 2662 www.cnmc.co www.teambest.com

AFRICA | ASIA | EUROPE | LATIN AMERICA | MIDDLE EAST | NORTH AMERICA

Huestis Medical

Huestis Medical is a well-known manufacturer of quality radiotherapy products, which include the Huestis•Cascade® radiographic/fluoroscopic simulator, AccuBoost® Partial Breast Brachytherapy Solution, the Huestis Styro•Former® manual block cutter, the Huestis Compu•Cutter® III computerized block cutter, and the Huestis Styro•Former® the original radiotherapy shielding block mold cutter. In addition, Huestis Medical manufactures collimators for a wide range of diagnostic X-ray applications and radiotherapy accessories such as measuring calipers and patient fixation devices.

Huestis Medical has assembled a collection of achievements and accreditations to document its commitment to quality manufacturing. Objectives and procedures are fully documented with an impressive array of accomplishments including ISO 9001 and ISO 13485 registration.



Compu•Cutter® III



Fixed Red or Green Diode Lasers



AccuBoost® Partial Breast Brachytherapy Solution



Huestis•Cascade® Simulator



Radiotherapy Calipers



Huestis Warming Oven

Huestis Medical • 68 Buttonwood Street • Bristol, Rhode Island 02809-0718 USA
tel 401 253 5500 800 972 9222 www.huestis.com www.teambest.com

AFRICA | ASIA | EUROPE | LATIN AMERICA | MIDDLE EAST | NORTH AMERICA



The TeamBest family of companies has been proudly developing, manufacturing, and delivering reliable medical equipment and supplies for over 40 years. TeamBest includes over a dozen companies offering complementary products and services for brachytherapy, health physics, radiation oncology, blood irradiation, vascular therapy, imaging, and medical particle acceleration. TeamBest is the single source for an expansive line of life saving medical equipment and supplies. Our trusted team is constantly expanding and innovating to provide the most reliable and cutting edge medical equipment and supplies to the global healthcare and research industries.

TeamBest started as Best Medical International, founded in Springfield, Virginia, USA by Indo-American engineer Krishnan Suthanthiran. Initially, Best Medical International employed only a handful of engineers and offered one high quality product, the Iridium-192 brachytherapy seed strand. Today, TeamBest employs hundreds of talented individuals and offers thousands of products and services. TeamBest's independently owned companies are proud to be represented in North America, Europe, Latin America, Africa, the Middle East, and Asia.

Krishnan Suthanthiran was born in India and educated in India and Canada. He tragically lost his father to cancer in 1968 and this event helped to formulate his main career goal—a life dedicated to medicine, particularly cancer research and treatment. During the past 50 years, he has founded multiple companies, investing hundreds of millions of US dollars globally in medical products manufacturing, healthcare delivery, real estate, entertainment and energy. Mahatma Gandhi dreamt of a free India. Today, it is the world's largest democracy. With a similar spirit of idealism, Suthanthiran has said that “I, too, have a dream—one shared by millions of our fellow citizens of the World—and a plan to realize this dream of quality healthcare and education that are affordable and accessible to all.” Suthanthiran strongly believes that “Everyone deserves the best healthcare, and education is the most effective way to eliminate poverty, improve global health and promote peace.” He has contributed substantially to setting up endowed chairs and endowments for scholarships at various universities and provided significant funding to support medical research and treatment by partnering with academic institutions, national labs, and hospitals around the world.

TeamBest Theratronics Asia, Pvt Ltd. • 2/299A Plot No. 36, 5th Cross Street
V.G.P. Prabhu Nagar • Perumbakkam • Chennai – 600100

Best Cure Foundation

The Best Cure Foundation was established in 2007 as a nonprofit entity to promote healthcare and education globally. The foundation's aim is to work with citizens, medical professionals, government and non-government organizations and educational institutions, as well as charitable institutions around the world, to eradicate contagious disease, malnutrition and poverty, and provide superior healthcare at low cost. Everyone deserves the best healthcare and education is the most effective way to eliminate poverty and promote global understanding and peace. Chapters will be set up globally to serve local and regional needs.

TeamBest Global companies in collaboration with the Best Cure Foundation plan to establish 100s of Best Cure Global Healthcare Delivery of Proactive, Preventive, Primary Care and Multi-specialty Medical Centers to serve the needs of the global cancer population. They aim to promote Total Health™ (prevention, early detection, effective treatment and total cure) and practice Proactive Healthcare™ (full transparency on benefits, clinical outcome and costs) and reduce the cost of healthcare by 30 percent or more.



3E— Education, Empowerment & Equality
is a division under BCF to promote the development and advancement of women

Best Cure Foundation 7643 Fullerton Road • Springfield, VA 22153 USA
tel 703 451 2378 www.bestcure.md

TeamBest Companies ©2025